

access
business development division



thyssenkrupp

Altura Diamond

PRODUCT CATALOGUE

Access. Everywhere. For Everyone.



Contents

Product Summary	4
Cabin	6
Control Panel	10
Simplicity Cabin	12
Deluxe Cabin	16
Doors	24
Door Options	31
Communication	33
Shaft	34
Drive	38
Technical Data	39
Pre-defined Plans	43

Altura Diamond cogbelt lifts comply with the Machine Directive 2006/42/EC by following the harmonized standard EN 81-41. They are also compliant with the Electromagnetic Compatibility Directive EMC 2014/30/EU and Low Voltage Directive 2014/35/EU.

EI 120 fire & smoke proof doors comply with EN 81-58 according to the Lift Directive 95/16/EC.

Altura Diamond cogbelt lifts are type approved and CE marked. Certificates are available on request.

	Model Codes	Product Codes	Commercial Name	Document name	Date
	BL41	BL4x-ES-FDC	Altura Diamond	CAT-BL41-00	February 2018
	BL46	BL4x-ST-FDC			
	BL47	BL4x-ES-SDC			
	BL48	BL4x-ST-SDC			

Product Summary

ALTURA DIAMOND

Driven by innovative cogbelt technology, the Altura Diamond redefines home lift luxury with its near silent operation and stylish details.

The Altura Diamond has a fully enclosed cabin, with one-touch operation and automatic doors. The lift is supplied with its own metallic shaft or can be installed in an existing masonry shaft.



Product Summary

TECHNICAL SPECIFICATIONS



Compliance:	European Machine Directive 2006/42/EC Reference standard EN 81-41
Drive system:	Cogbelt and counterweight system, driven by a gearless motor
Rated speed:	Europe: max. 0.15 m/s (2006/42/EC). Up to 0.4 m/s outside Europe, where permitted by local regulations
Travel (minimum - maximum):	1100 – 18000 mm
Distance between intermediate floors:	Minimum 250 mm
Number of stops:	Maximum 6 stops per lift
Doors:	Maximum 2 doors per floor / 12 doors per lift
Type of accesses:	Frontal, lateral, opposite or adjacent
Pit:	140 mm. If a pit is not possible, the lift can be used with a ramp
Shaft type	Metallic structural shaft, or existing masonry shaft.
Shaft top height:	Structural shaft: 2450 - 2630 mm Masonry shaft: 2350 - 2450 mm
Cabin types:	Fully enclosed with sliding doors or with folding doors
Controls:	Automatic (one-touch) controls on cabin and landing. Call reservation on landings.
Display panels	Cabin display and optional landing displays, with TFT screen
Application:	Indoor or outdoor
Emergency lowering:	Battery operated emergency lowering with UPS
Control voltage:	24 V
Motor:	2.8 kW
Power requirements:	1-phase 230 V AC 50/60 Hz
Maximum power:	1.85 kW (when used at 0.15 m/s) 3.5 kW (for up to 0.4 m/s)
Circuit breaker / RCD	6A tripping curves C / 30 mA class A or B
Rated load:	250 - 400 kg depending on cabin size

Product Codes

Model Code	Max Speed	Certification
BL41	0.15 m/s	CE type approved
BL46	0.3 m/s	Outside EU in selected countries
BL47	0.35 m/s	
BL48	0.4 m/s	

Cabin

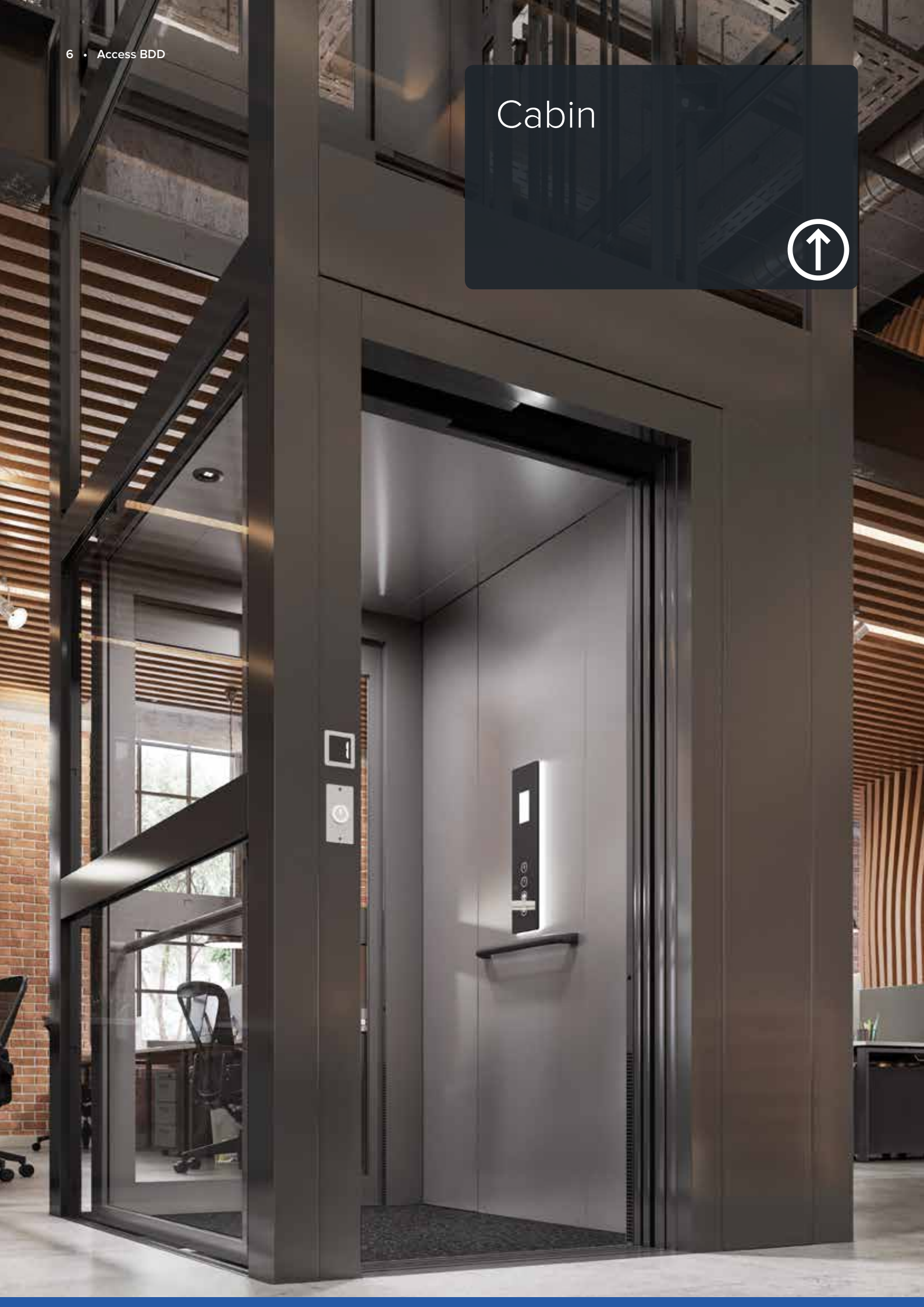

Cabin Dimensions

PRE-DEFINED PLAN SIZES

The Altura Diamond is available in eight pre-defined plan sizes as listed below, or the lift can be built to specific dimensions within the minimum and maximum values shown in the table on p42.

The rated load according to EN81-41 (250 kg/m²) depends on the cabin size and optional features, with a maximum possible load of 400 kg.

Altura Diamond: Pre-defined plan sizes

Nominal cabin dimensions (mm)	Nominal floor area (m ²)	Rated load EN81-41 (kg)	Max load * (kg)
900 x 1200	1.08	270	325
1000 x 800	0.80	250	325
1000 x 1000	1.00	250	325
1200 x 1000	1.20	300	400
1200 x 1200	1.44	360	400
1400 x 900	1.26	315	400
1400 x 1000	1.40	350	400
1400 x 1100	1.54	385	400

*Maximum load is subject to a feasibility check

Cabin Door Configurations

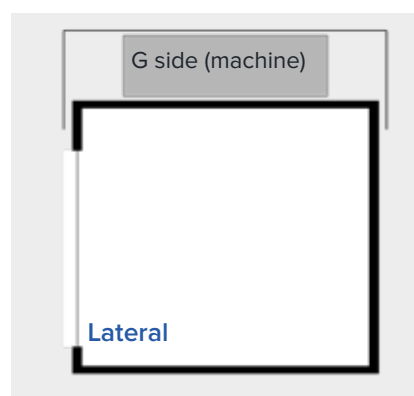
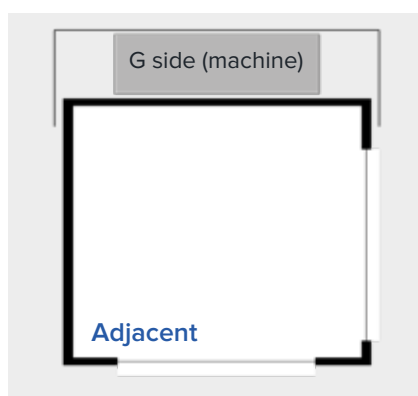
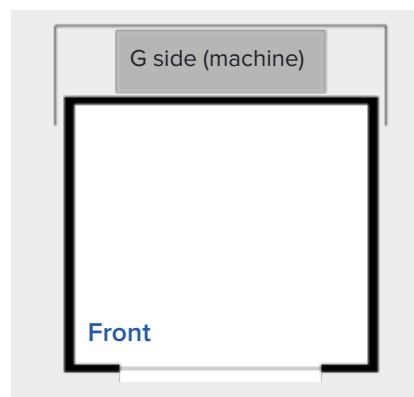
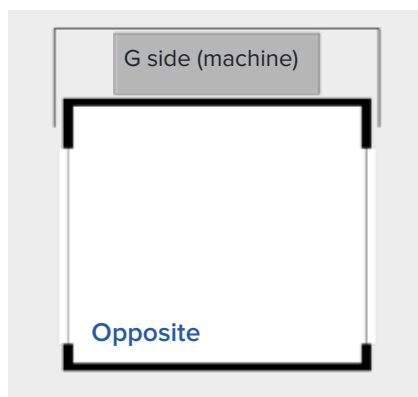

Cabin with sliding doors

SLIDING DOORS: CABIN AND LANDING



Automatic telescopic doors on each cabin and landing access (maximum two accesses per floor). Each access is protected with photocells or with full height light curtains.

- 2 panel side opening or 4 panel central opening
- Optional glass panels on cabin and landing doors

Cabin door finishes

The insides of the cabin doors are available in the same range of options as the cabin walls:

- Painted in choice of colour
- Finished with skinplate
- Stainless steel

For more details, see the cabin pages from p14 onwards.

Cabin and door heights

2100 mm cabin height with net door height 2000 mm

In the case of the Deluxe cabin with false ceiling, the net cabin height is reduced by 70 mm.

Landing sliding door options

- Stainless steel
- Metal-effect or other colour film (see pp 14-15)
- Painted in choice of colour
- Fireproof doors

Dimensions

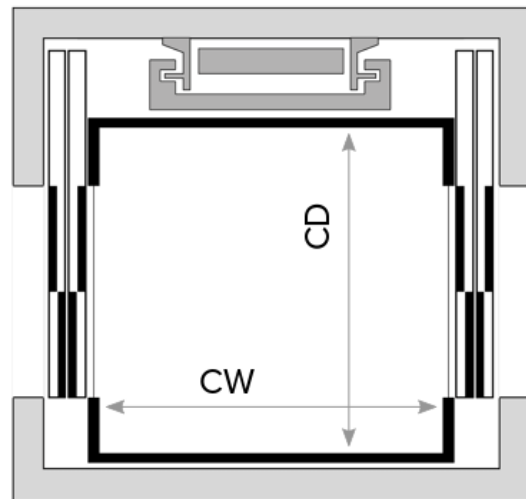

Maximum and minimum sizes (CW x CD)

Smallest cabin: 750 mm x 650 mm

Cabin with maximum width: 1400 mm x 1100 mm

Cabin with maximum depth: 1200 mm x 1200 mm

See pp 42-47 for feasibility information and a selection of pre-defined plan sizes

Cabin with folding doors

CABIN FOLDING DOORS / LANDING SWING DOOR



Automatic folding cabin doors (four panels) are also available. When folding doors are used, the landings are fitted with swing doors.

Folding cabin door options

- Painted in choice of colour
- Stainless steel
- Optional glass panels

Cabin and door heights

2100 mm cabin height with net door height 2000 mm

In the case of the Deluxe cabin with false ceiling, the net cabin height is reduced by 70 mm.

Options for landing swing door: see pp 28-29

Dimensions

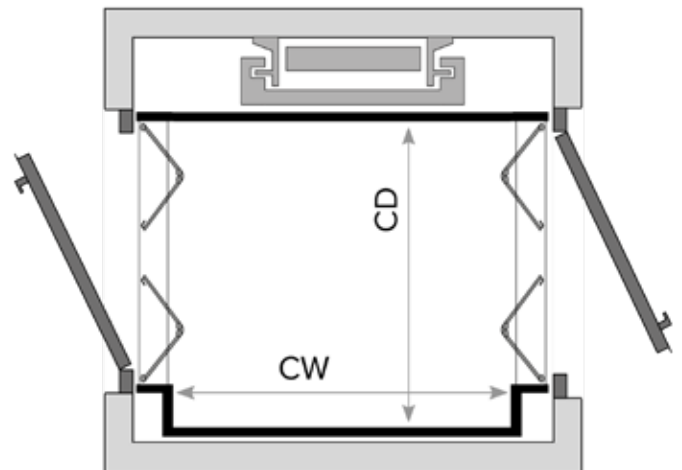

Maximum and minimum sizes (CW x CD)

Smallest cabin: 750 mm x 650 mm

Cabin with maximum width: 1400 mm x 1100 mm

Cabin with maximum depth: 1200 mm x 1200 mm

See pp 42-47 for feasibility information and a selection of pre-defined plan sizes.

Control Panel

STANDARD FEATURES

The sleek design of the Altura Diamond control panel is enhanced by a white backlight around the profile.

The control panel has a polished black finish as standard, with mirrored steel or a gold effect offered as options on the Deluxe cabin. The control panel is always fitted on the machine side of the cabin.



BLACK (standard)



MIRRORED STEEL



GOLD EFFECT

Handrail

A handrail with a minimum cross-sectional diameter of 30 mm is supplied with all lifts, as required by EN81-41. The height between the platform floor and top edge of the handrail is 900 mm +/- 25 mm. The handrail is available in black or stainless steel for the Simplicity cabin and stainless steel or gold effect for the Deluxe cabin. Handrails can be fitted on any wall of the cabin, including the control panel side, and in a 1400 mm width cabin, a two-piece rail can be fitted either side of the control panel.



Control Panel Buttons

The diameter of the destination buttons is 37 mm, and height of the centre line of the button panel is between 900 and 1100 mm from the platform floor, in accordance with EN 81-41. The buttons include Braille as standard.

Destination buttons

The buttons are available with the following letters and numbers: -2, -1, 0, 1, 2, 3, 4, 5, 6, B, BG, BV, G, K, KV, P, U, E.

Alarm button

The alarm button is included as standard and is connected to an external alarm sounder and to an optional auto-dialler. When the button is pressed, the siren will give a loud signal outside the lift to attract attention in case of emergency and, if fitted, the alarm auto-dialler calls a pre-programmed emergency number.

Control Panel

ADDITIONAL OPTIONS

A full-colour display on the control panel shows floor indicators and other system information. Additional security features are offered to protect users in public buildings and to prevent unauthorised use.

Colour Display

The display is positioned on the control panel above the floor buttons and shows the following information:

- Floor indicator showing the position of the lift.
- An arrow indicating the direction of the lift when travelling
- Icons giving status information:
 - Bell: the alarm button has been pressed.
 - Weight symbol: the lift is overloaded.
- An error code for diagnostics.
- If the lift is connected to the building's fire alarm system, a symbol will be shown when alarm is activated (see below).

Voice announcements can also be provided with the display. These are available in English, Italian, French, German, Spanish, Dutch, Portuguese, Czech and Russian.



Building Integration



The lift can be connected to the building's fire alarm.

If the fire alarm is activated, a symbol on the display will be shown and the lift will move to a predetermined floor and park there.

Key Switch on Control Panel



Use of the lift can be controlled by key-switches placed on the control panel. The control panel can either be fitted with a general key switch which locks the entire operation of the lift, or the floor buttons can be replaced with individual key switches (up to a maximum of 4 per lift) to control access to specific floors.

There are two key options to choose from:

- standard mechanical key
- i-button for one-touch operation.

User-specific configurations can be designed: please contact us for details.

Simplicity Cabin

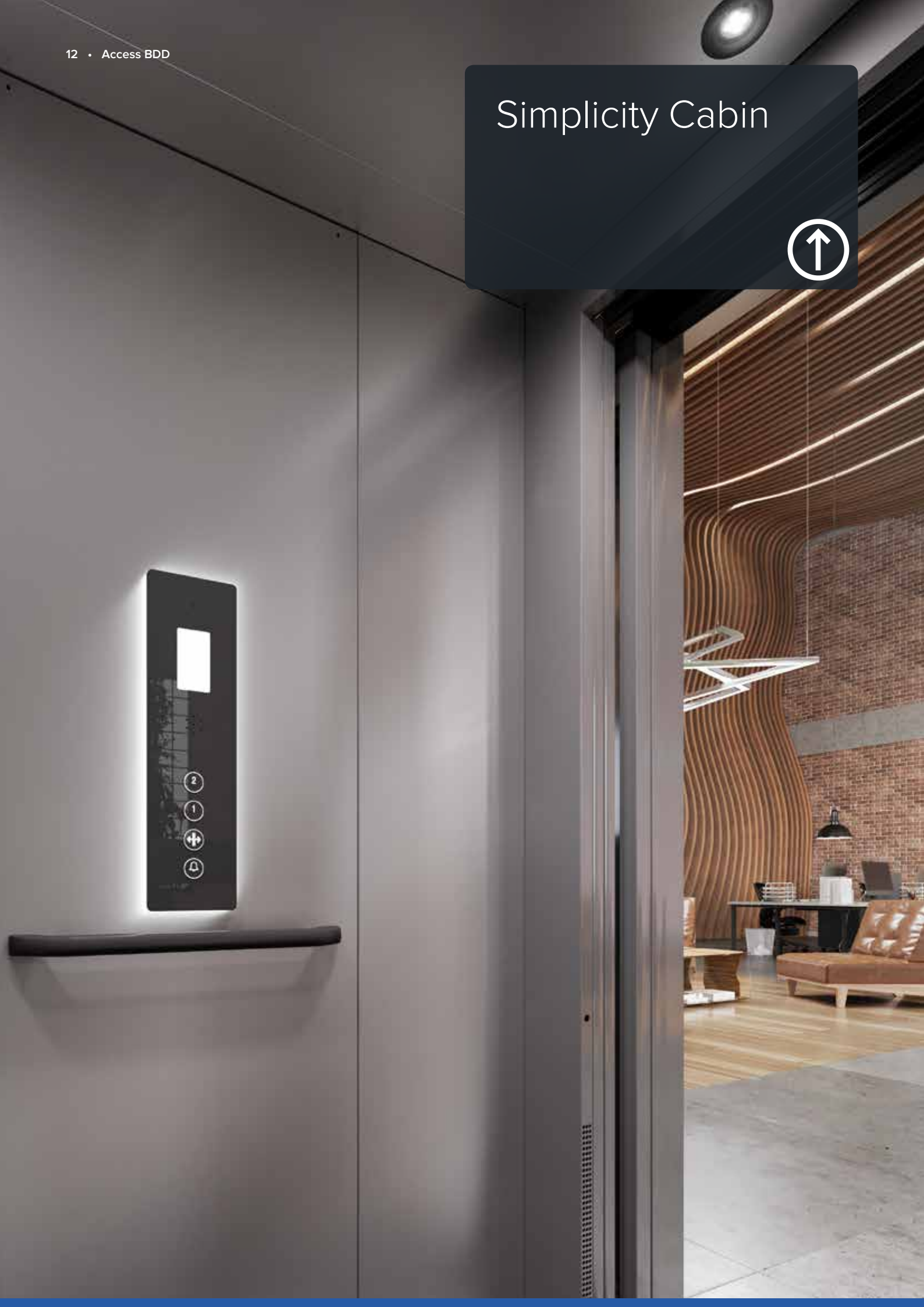

Simplicity cabin

DESIGN AND LAYOUT

The Altura Diamond Simplicity cabin has a clean and streamlined look, aligned to other products in the Altura Lift family.

Cabin Walls

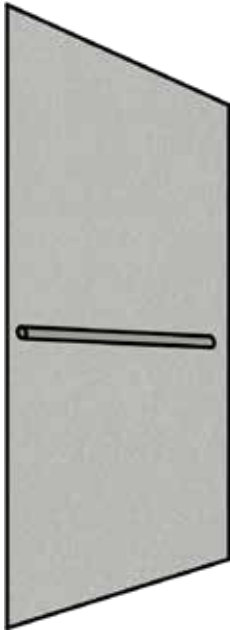

Plain walls

Skinplate, stainless steel or painted in a choice of colour. The insides of the doors can be finished to match the walls. See options on following pages.

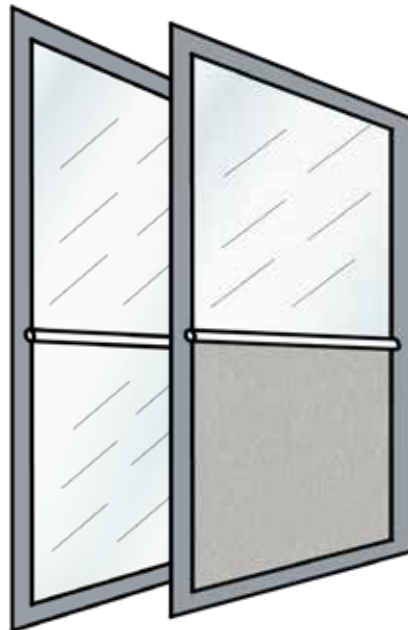

Glass walls

Full-height or half-height, plain glass can be selected for any wall except the machine side. A handrail is required on full-height glass panels.

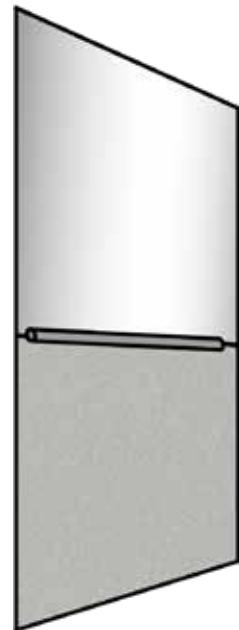

Mirror

A half height mirror can be affixed to any wall except for the machine side.

Ceiling



The Simplicity cabin has a plain ceiling and is illuminated with three LED spotlights.

Simplicity Cabin

INTERIOR OPTIONS

The Simplicity cabin can be customised with a choice of colours and finishes for the walls, floor and cabin doors.

The cabin walls are made of steel and can be covered with a coloured plastic or stainless steel finish or painted with a choice of RAL colour (gloss 80-90, orange peel finish, coarse grade). Suggested RAL matches for the other painted parts of the lift are given for each skinplate option.

As standard, the whole lift is painted in RAL 9010 (pure white) and the console wall is coated in skinplate A4 – milk.

Cabin Wall Options

Plain skinplates

Steel panel with a solid colour textured plastic coating

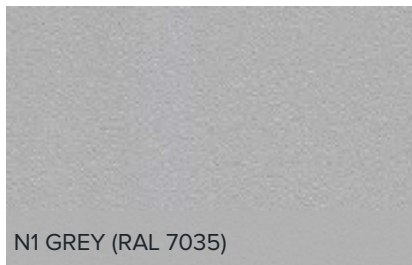
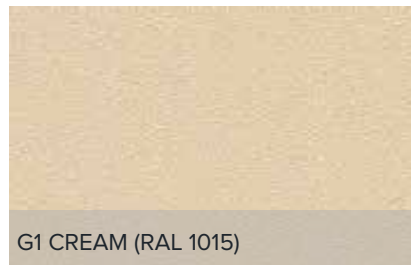

NOTE: RAL Colours
 For all parts of the lift where RAL painting is offered, the choice of colour can be made from the 213 colours in the RAL Chart K7 Classic, excluding pearl and metallic colours. If no colour is specified, the standard colour for all painted parts is RAL 9010 (white). Painting is powder coating with orange peel finish, visual gloss 80-90.

All parts can show small colour differences, this is normal and unavoidable. While we take every precaution to minimize visible differences, this cannot be guaranteed.

Simplicity Cabin

INTERIOR OPTIONS

Stainless steel



Patterned skinplates

Steel panel coated with lightly patterned smooth finish

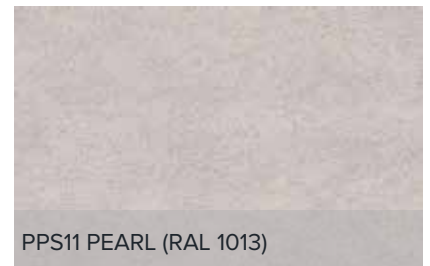

Flooring

Safety vinyl flooring, with life-time non-slip guarantee. The lift can also be supplied without flooring if you want to use your own. For flush alignment with the landing, customer supplied flooring should be maximum 3 mm deep.



Deluxe Cabin



Deluxe Cabin

DESIGN AND LAYOUT

Exclusively available on the Altura Diamond, the Deluxe Cabin has a choice of luxurious wall finishes, with contrasting accents and a suspended ceiling with a choice of soft lighting options.

Design your own Deluxe cabin by choosing from our range of interior options on pp 18-19 or pick a cabin style from our Diamond Collection (pp 20-23).



Walls

A choice of high-pressure laminates, with contrasting central panel and corner accents: see options on the following pages.

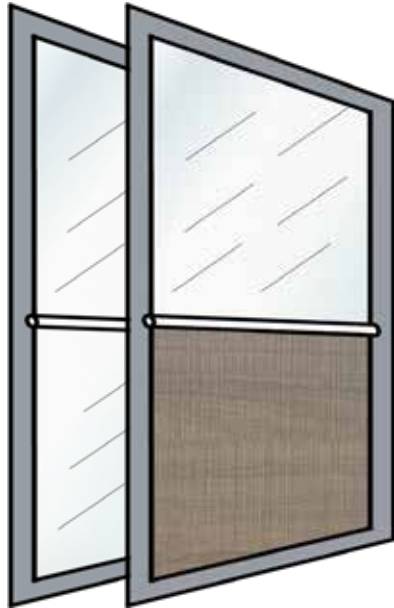

Glass

Full-height or half-height, plain glass, available on all walls except the control panel wall (G side). A handrail is required on full-height glass panels.



Mirror

Full-height, half-height or slim vertical mirrors can be fitted to any wall except the control panel wall (G side). A mirrored central panel for the G side is also available (see options p19)

Ceiling

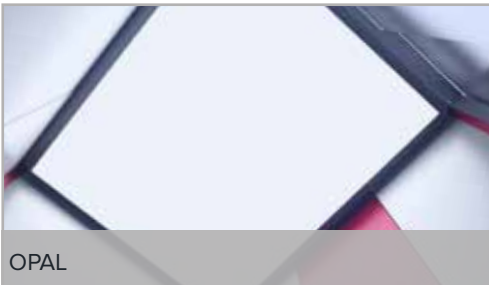

OPAL

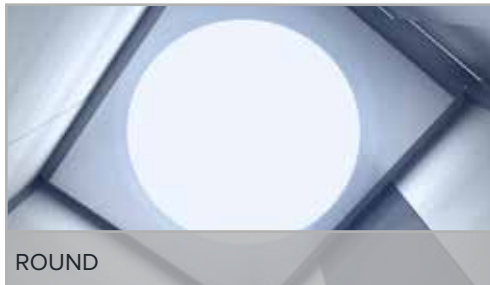

ROUND



PLAIN STEEL



STARRY SKY

Reference image left shows: walls – 4367, bright wood, accents – grey 7012, floor – white carpet, ceiling – plain

Walls and Floors

DELUXE CABIN

Walls: high-pressure laminate panels



Wood Effect

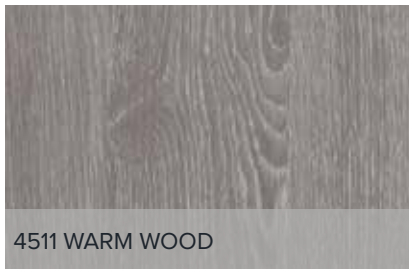
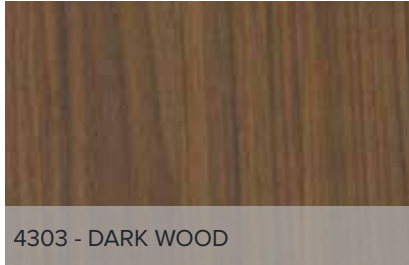

Textured Effect

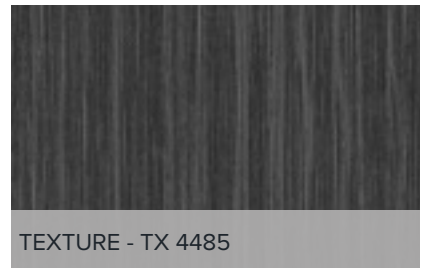

Stone Effect

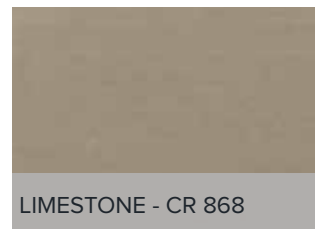
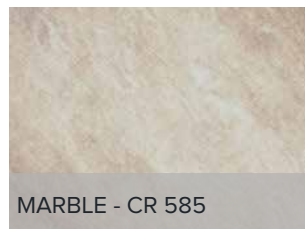

All parts can show small colour differences, this is normal and unavoidable. While we take every precaution to minimize visible differences, this cannot be guaranteed.

Walls and Floors

DELUXE CABIN

Central panel and corner accents



Flooring

Granite Effect

Composite stone, with a polished granite effect finish

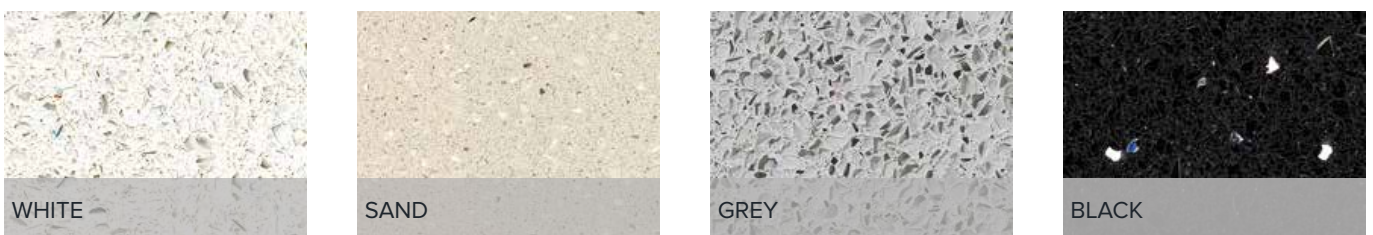

Carpet

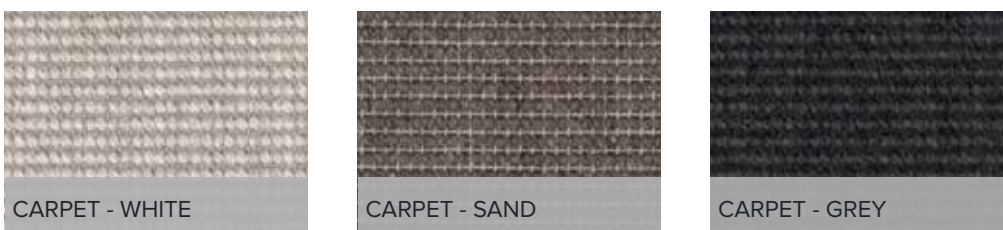

The vinyl flooring from the Simplicity range can also be selected for the Deluxe cabin, or the cabin can be supplied without flooring for the customer to apply their own.

All parts can show small colour differences, this is normal and unavoidable. While we take every precaution to minimize visible differences, this cannot be guaranteed.

Diamond Collection

MODERN RANGE



1. MODERN EUROPE



2. MODERN AMERICAS



3. MODERN ASIA

1. Modern Europe

- Wall: Bright wood 4515
- Accent: Black 7021
- Ceiling: Round
- Flooring: Grey vinyl
- Mirror: None
- Handrail: Stainless steel, 2 pieces

2. Modern Americas

- Wall: Concrete 3311
- Accent: Blue 5024
- Ceiling: Plain
- Flooring: Grey vinyl
- Mirror: Slim vertical
- Handrail: Stainless steel, 2 pieces

3. Modern Asia

- Wall: Texture 2606
- Accent: Red 3003
- Ceiling: Opal
- Flooring: Grey vinyl
- Mirror: None
- Handrail: Stainless steel, 2 pieces

(2 piece handrails for 1400 wide cabin only)

Diamond Collection

CLASSIC RANGE



4. CLASSIC EUROPE



5. CLASSIC AMERICAS



6. CLASSIC ASIA

4. Classic Europe

- Wall: Cool wood 4511
- Accent: Beige 1019
- Ceiling: Plain
- Flooring: Sand carpet
- Mirror: Full wall
- Handrail: Stainless steel, 2 pieces

5. Classic Americas

- Wall: Texture 3318
- Accent: Light grey 7035
- Ceiling: Plain
- Flooring: Grey vinyl
- Full height panoramic wall
- Handrail: Stainless steel on panoramic wall

6. Classic Asia

- Wall: Dark wood 4303
- Accent: Red 3003
- Ceiling: Plain
- Flooring: Grey vinyl
- Mirror: Half wall
- Handrail: Stainless steel 2 pieces

(2 piece handrails for 1400 wide cabin only)

Diamond Collection

NATURAL RANGE



7. NATURAL EUROPE



8. NATURAL AMERICAS



9. NATURAL ASIA

7. Natural Europe

- Wall: Warm wood 4533
- Accent: Green 6011
- Ceiling: Plain
- Flooring: Grey carpet
- Mirror: None
- Handrail: Stainless steel, 2 pieces

8. Natural Americas

- Wall: Texture 4485
- Accent: Dark grey 7012
- Ceiling: Plain
- Flooring: Sand carpet
- Mirror: None
- Handrail: Stainless steel, 2 pieces

9. Natural Asia

- Wall: Bright Wood 4367
- Accent: Green 6011
- Ceiling: Plain
- Flooring: Grey carpet
- Mirror: None
- Handrail: Stainless steel, 2 pieces

(2 piece handrails for 1400 wide cabin only)

Diamond Collection

INTERNATIONAL RANGE



10. INTERNATIONAL MODERN



11. INTERNATIONAL NATURAL



12. INTERNATIONAL CLASSIC

10. International Modern

- Wall: Limestone 868
- Accent: Steel mirror
- Ceiling: Plain
- Flooring: Customised
- Handrail: Stainless steel, 2 pieces

11. International Natural

- Wall: Marble 585
- Accent: Dark grey 7012
- Ceiling: Plain
- Flooring: White carpet
- Mirror: None
- Handrail: Stainless steel

12. International Classic

- Wall: Concrete 1117
- Accent: Steel gold
- Ceiling: Plain
- Flooring: Granite effect - sand
- Mirror: None
- Handrail: Stainless steel, 2 pieces

(2 piece handrails for 1400 wide cabin only)

Doors



Sliding Doors

CABIN AND LANDING

Sliding doors: lateral opening with blind panels

- Door height (HL): 2000 mm.
- Door frames: 100 mm on each side (M1, M2, HD).
- Door sill: landing - 90 mm, cabin - 70 mm).
- Frame depth: 60 mm (FD).
- Opening: right or left, with two panels.
- A triangular key for the lock release is provided with each machine.
- Standard installation is fully within the shaft. Sliding door encumbrance in the shaft (DHP) = 110 mm.
- Fire-proof door available as option.

Door clear access (PL)	Total width (1.5PL + 145)
600 mm	1045 mm
700 mm	1195 mm
800 mm	1345 mm
900 mm	1495 mm

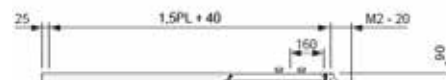
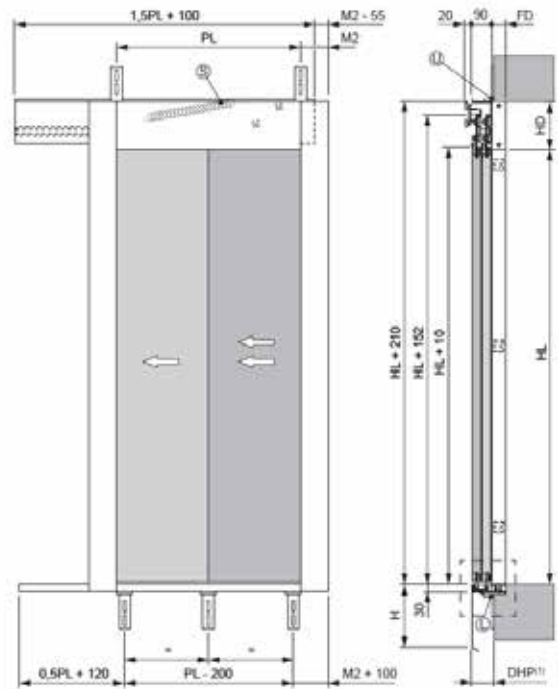

Sliding doors: lateral opening with glass panels

- Door and frame dimensions are the same as the blind version
- Panel dimensions depend on the door clear access as shown in the diagram (PL/N+20), where N is the number of panels
- The frame around the glass has standard dimensions and has a satin stainless steel finish.

Frame dimensions:

Top and bottom: 120 mm. Lateral: 40 mm and 60 mm

Glass and panel sizes for lateral opening, 2 panels:

Door clear access (PL)	Panel size	Glass size
600 mm	320 mm	220 mm
700 mm	370 mm	270 mm
800 mm	420 mm	320 mm
900 mm	470 mm	370 mm

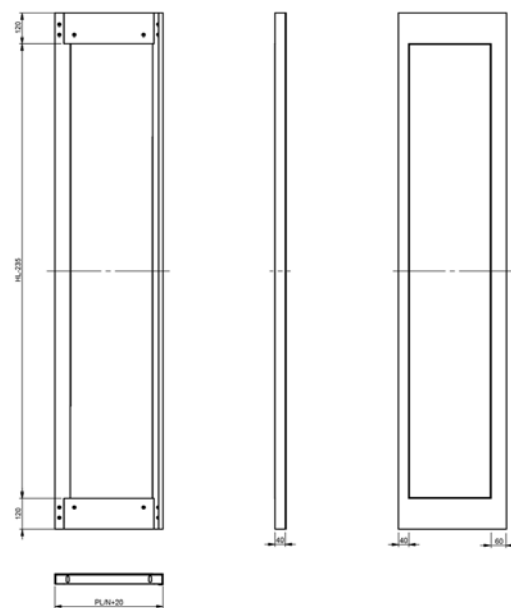

Sliding Doors

CABIN AND LANDING

Sliding doors: central opening with blind panels

- Door height (HL): 2000 mm.
- Door frames: 100 mm on each side (M1, M2, HD).
- Door sill: landing - 90 mm, cabin - 70 mm).
- Frame depth: 60 mm (FD).
- Opening: central, with four panels.
- A triangular key for the lock release is provided with each machine.
- Standard installation is fully within the shaft. Sliding door encumbrance in the shaft (DHP) = 110 mm.
- Fire-proof door available as option.

Door clear access (PL)	Total width
600 mm	1040 mm
700 mm	1165 mm
800 mm	1300 mm
900 mm	1450 mm

The table below shows the tolerance (G) required to install the doors. The narrower the door opening, the greater the tolerance required.

PL	G
600 mm	40 mm
650 mm	30 mm
700 mm	15 mm
≥ 750 mm	0 mm

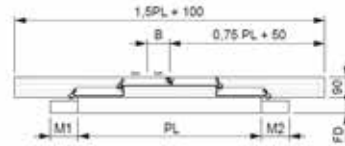
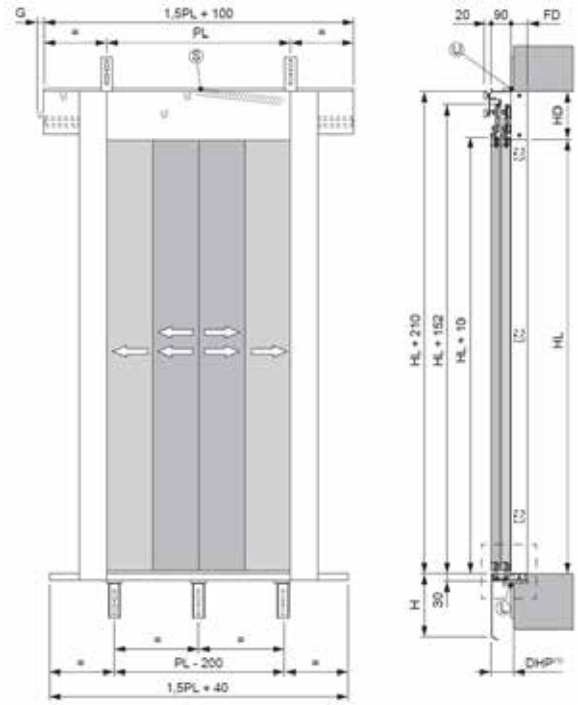

Sliding doors: central opening with glass panels

- Door and frame dimensions are the same as the blind version
- Panel dimensions depend on the door clear access as shown in the picture (PL/N+20), where N is the number of panels
- The frame around the glass has standard dimensions and has a satin stainless steel finish

Frame dimensions:

Top and bottom: 120 mm. Lateral: 40 mm and 60 mm.

Glass and panel sizes for central opening, 4 panels:

Door clear access (PL)	Panel size	Glass size
600 mm	170 mm	70 mm
700 mm	195 mm	95 mm
800 mm	220 mm	120 mm
900 mm	245 mm	145 mm

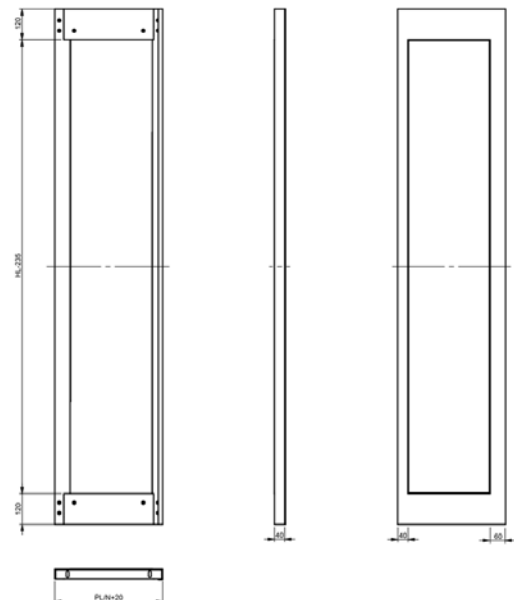

Folding Doors

CABIN

Folding doors: blind panels

- Door height: 2000 mm.
- Door sill of landing door: 100 mm
- Opening: central, with four panels

"A" is the maximum encumbrance in the cabin with the doors open.

Door clear access (DA)	A
600 mm	90.5 mm
700 mm	111.5 mm
800 mm	140.5 mm
900 mm	165.5 mm

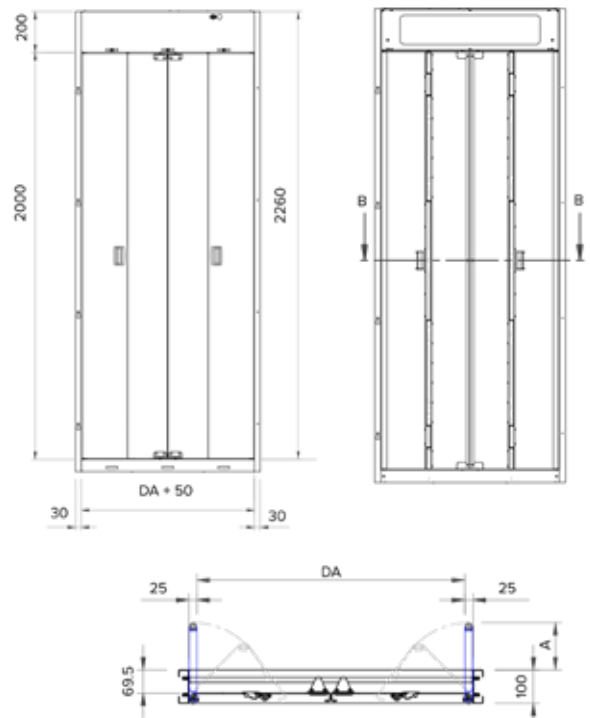

Folding doors: glass panels

- Dimensions and finishes are the same as the blind version.
- Two models are available, with or without handles on the inner side.
- Glass dimensions depend on the door clear access, as shown in the table below:

Door clear access (PL)	Glass size B	Glass size C
600 mm	65 mm	97 mm
700 mm	90 mm	122 mm
800 mm	115 mm	147 mm
900 mm	140 mm	171 mm

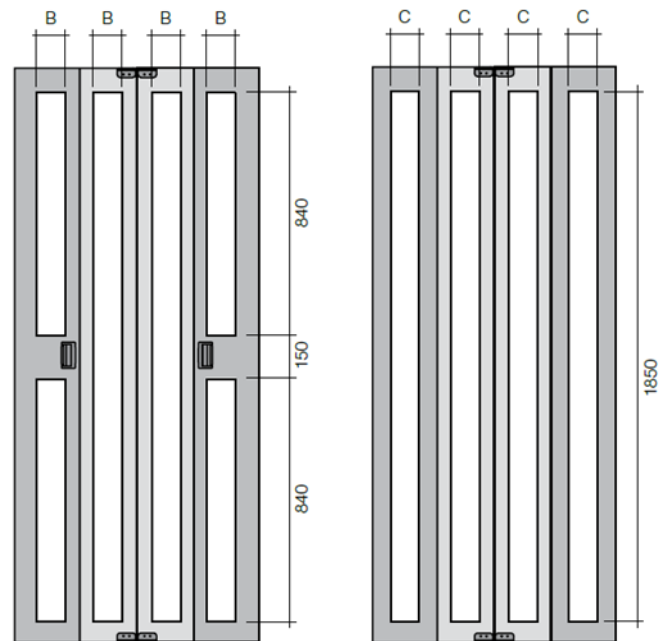

Glass folding doors with handle Glass folding doors no handle

For doors with height 2000 mm

B = Door clear access/4 - 85

C = Door clear access/4 - 53

Landing Swing Door

DIMENSIONS

General information

When folding doors are selected for the cabin, swing doors are fitted on the landings. Swing doors can be blind or panoramic. The large window on the panoramic doors is made of Visarm safety glass 10/11 mm thick.

Door frame

The swing doors are always delivered with frames which are painted in the same colour as the door. Note that it is not possible to order the door or the frame separately. The doors can be hinged on the left or on the right.

The door frames have dimensions of 100 mm on each side. When an automatic door opener is used on doors in a concrete shaft, the top frame is 140 mm.

The actual height of the door is 40 mm higher than the net height.

Door specifications

Opening widths: 600, 650, 700, 750, 800, 850, 900 mm

Opening height: 2000 mm

Total door height (including frame): 2100 mm / 2140 mm

Other dimensions may be available on request

Door options

- Door and door frame painted in choice of RAL colour (see note p14) or metallic paint (see p36)
- Panoramic window: transparent, opaque, semi-reflective, smoky grey or smoky satin (see p36)

Glass window: 470x1600 mm (door width 700 mm)
 (Panoramic) 570x1600 mm (door width 800 mm)
 670x1600 mm (door width 900 mm)



Door net width (mm)	Door total width including frame (mm)
600	800
650	850
700	900
750	950
800	1000
850	1050
900	1100



BLIND DOOR



PANORAMIC DOOR

Landing Swing Door

ADDITIONAL OPTIONS

The standard swing doors on landings are opened manually and closed semi-automatically by way of a simple closing spring.

The time and speed of the standard semi-automatic swing doors are not adjustable. For greater control over the operation of the swing doors, automatic openers and closers are available. The automatic openers and closers are not available with fire-proof doors.



Internal door closer

The internal door closer is available as an option. It closes the door automatically and includes a function to keep the door open until the user manually closes it. The internal door closer is contained within the door frame, making it invisible from the outside. The closing speed is adjustable.



External Door opener – optional

The external door opener opens the door automatically once the lift has arrived at the landing and closes it after a pre-set time. The opening and closing time and speed are adjustable.

It is mounted on the top frame of the door inside a box with a white painted cover.

When automatic door openers are fitted on two doors at the same landing, the doors will open simultaneously.

Door Handles



HANDLE TECHNO



HANDLE MODERN

The landing swing doors have a stainless steel handle. The "Techno" handle is supplied as standard, or the longer "Modern" version can be ordered as an option.

Handle Dimensions

Techno: Length 207 mm

Modern: Length 350 mm, diameter 20 mm

Door Options

EI120 FIRE AND SMOKE-PROOF DOORS

Fire and smoke-proof landing doors are available as an option for indoor installations only.

The swing and sliding landing doors can be supplied in a fire and smoke-proof version that complies with EN 81-58. Glass panels and window are not available on fire and smoke-proof doors.

Note: a wall mounted call box must always be ordered for the landing control, as it cannot be installed in the frame of fireproof doors. (See p.32)

Swing doors EI120

The fire and smoke-proof landing swing doors are always delivered with a frame which is 100 mm wide on each side.

Opening widths: 600, 650, 700, 750, 800, 850, 900 mm
Opening height: 2000 mm

The actual height of the door is 2040 mm due to a plate which is mounted on the door to cover the gap between the door and the frame. The door and frame can be painted in any RAL colour. If no colour is specified, they are supplied in white (RAL 9010).

Sliding doors EI60 or EI120

Fire- and smoke-proof sliding doors for the landing are available with two-panel lateral opening or four-panel central opening. As standard they are painted in grey; other colours or a stainless-steel coating are available as an option.

The fire and smoke-proof sliding doors are always supplied with blind panels.



Ramp

When used with a metallic shaft, we recommend that the lift is installed in a pit, with a depth of 140 mm. If the lift is installed without a pit, a ramp is mandatory according to EN81-41.

An aluminium ramp with a non-slip surface can be ordered as an option. The width of the ramp corresponds to the width of the corresponding shaft side and the vertical rise is less than 1:4.



Door Options

CONTROLS

A backlit button on each landing is used to call the lift.

The landing control button is normally located on the frame of each landing door. When swing doors are used, it is placed on the same side as the door handle. Optionally, it can be placed away from the lift in an external control box.



Call button

The call button shows the floor number and has Braille as standard. It has a backlit frame which changes colour to indicate the status of the lift.

- Green: the lift is at this floor.
- Red: the lift is currently in use.
- A flashing light is used to give a warning status.

Landing Indicator Display

As an option, a digital display can be positioned on the door faceplate. The landing display shows the following information:

- Floor indicator showing the position of the lift.
- An arrow indicating the direction of the lift when travelling
- Icons giving status information:
 - Bell: the alarm button has been pressed.
 - Weight symbol: the lift is overloaded.
- An error code for diagnostics;
- Out of service status message

The landing indicator display is available for indoor use only.

Door Locking Options

A lock with a key switch or an i-button, or a lock prepared for the EUR key, can be provided either in addition to, or instead of, the call button.

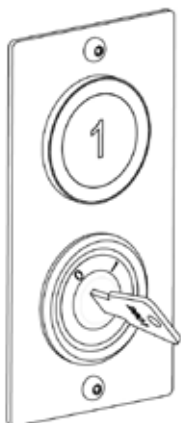

Key switch and call button

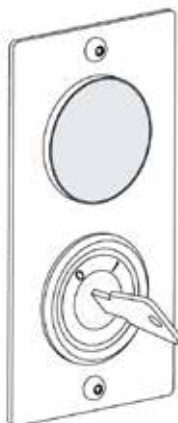

Key switch without button

Key switch with call button

The key is used to unlock the landing control button. Once the lock is in the open position, the lift can be used with the call button as normal. This option is recommended when a lift needs to be made available to all users during particular hours of the day.

Key switch without call button

When there is no call button, the lift can only be called and accessed with the key. The key switch includes a school locking function which automatically locks the door after a set time.

Only one key switch is available per door.

Door Options

WALL MOUNTED DOOR CONTROL

The landing control panel can be wall mounted away from the door frame in an external call station box.

The wall-mounted landing control is situated in an external call station box connected to the lift via a cable at a maximum of 10 m from the lift. It can be surface mounted or flush mounted. The external control box must be ordered if the EI 120 fire and smoke-proof door is used.

Dimensions:

Without display: 130 x 70 x 55 mm

With display: 220 x 95 x 55 mm

Door control: dimensions for flush wall mounting

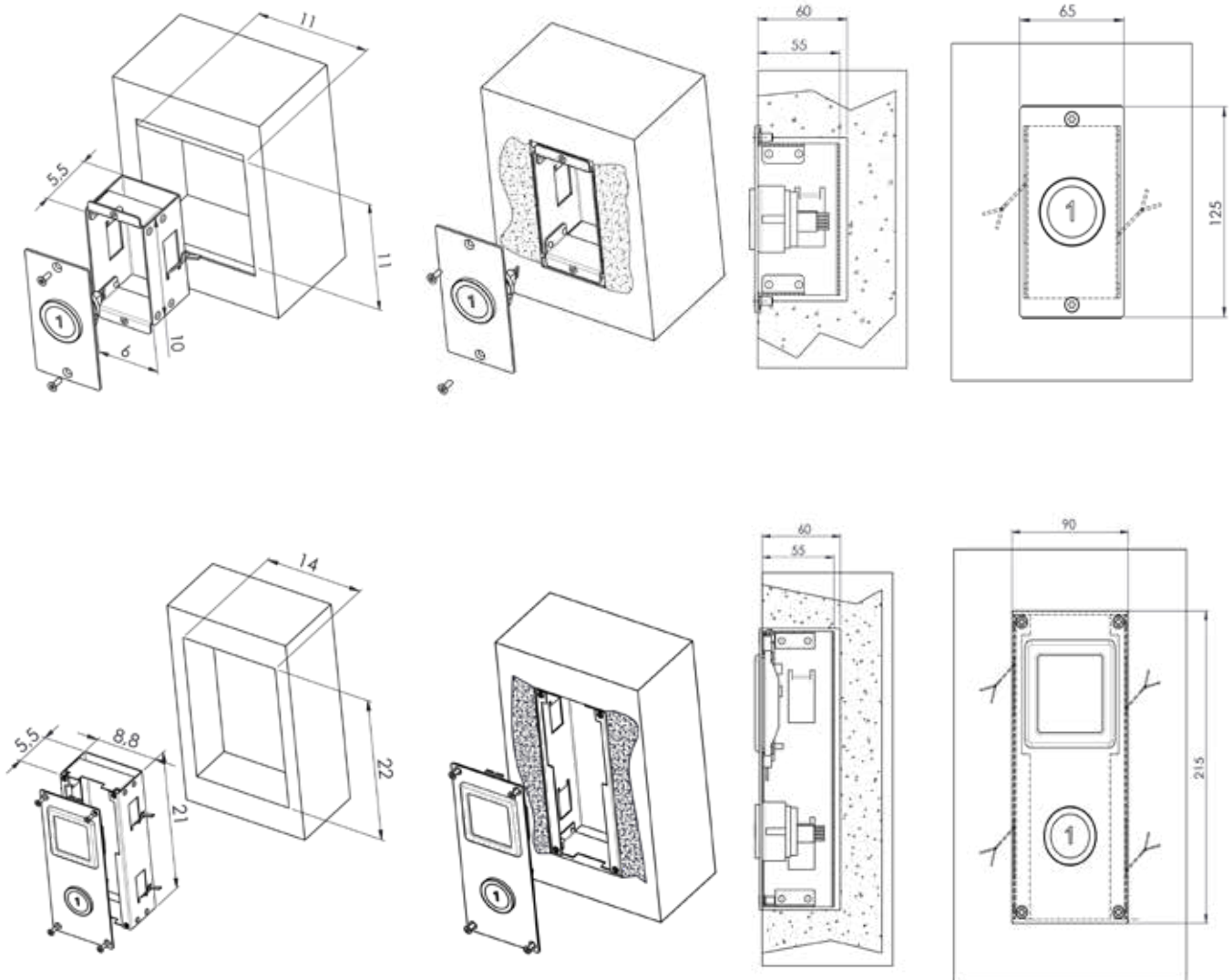

Communication

Two way communication is supplied as standard inside the cabin.

A communication system in case of emergency is required for compliance with EN81-41. The standard supply is a telephone handset, or an auto-dialler in the control panel can be ordered as an option.

The user is responsible for supplying a landline or SIM card for connecting the lift to a telephone network.



Telephone Handset

As standard, a telephone handset is mounted on the console wall next to the control panel. It is to be connected to a landline in the building,

Auto-dialler (option)

The auto-dialler equipment is integrated in the control panel and connected to the alarm button. When the alarm button is kept pressed for 3 seconds, the auto-dialler calls through a sequence of up to 7 pre-programmed numbers until answered.

The auto-dialler is connected to the building's landline or can be fitted with a GSM module for connection to the mobile phone network.

Shaft



Shaft

METALLIC SHAFT: BASIC INFORMATION

The Altura Diamond can be delivered with a metallic shaft or installed in a masonry shaft. The metallic shaft is free of rivets and silicon. It is weatherproof and suitable for seismic conditions.

The standard height of the shaft at the upper floor (from top floor to top of shaft) is between 2450 - 2630 mm, depending on the type of roof and landing doors: see table below. This includes a free height of 30 mm above the shaft for installation purposes. Elongation of the shaft is possible.

The shaft is powder coated with an orange peel finish (coarse grade) and painted with a gloss level of 80-90 in a RAL colour of choice, or in a selection of metallic colours. (See p.14 for RAL options and p.36 for metallic colours). If no colour is specified, the shaft is painted white (RAL 9010).

Shaft ceiling types

The shaft is available with diagonal bars, a flat roof or an inclined roof. The roof is in one or two pieces, depending on the shaft dimensions.

Shaft height at upper floor:

Model	Installation	Folding / swing doors	Sliding doors
Concrete shaft	Any	2350 mm	2450 mm
Metal shaft with diagonal bars	Indoor	2450 mm	2590 mm
Metal shaft with flat roof	Indoor	2470 mm	2610 mm
Metal shaft with inclined roof	Outdoor	2490 mm	2630 mm

Note: seismic conditions:

The shaft structure is designed to be used in locations where a seismic event can occur. The structure has been checked according to the requirements of the Eurocodes and NTC2008 (Italian reference standard) which provide guidelines on the structural calculation in seismic conditions.

However, it is not possible to state a priori the degree of resistance according to an earthquake's strength scale. The structure must be checked according to the stratigraphic and topographical conditions of the soil and subsoil and of the predictable ground acceleration in these areas. The behaviour and the resistance capacities of the structure also depend on its geometry and boundary constraint conditions.

Specific verification may be necessary according to local regulation. Please contact us for further information in specific cases.



Shaft

PANEL OPTIONS

The metallic shaft is available with plain painted steel or glass panels

All four sides of the shaft are clad with panels in steel or glass, and fitted with a special gasket for water management. The lowest panel on machine side is always a ventilation panel, made of steel and painted in the same colour as the shaft (see right). The ventilation panel reduces the effect of condensation inside the shaft.

- **Steel:** galvanized steel, painted with standard RAL colour or a metallic colour from the selection below.
- **Glass panels:** laminated safety glass 8/9 mm (4+0.76+4), in choice of five different glass types.

The shaft can have a mixture of steel sides and glass sides.



Metallic Colours

In addition to the standard RAL range (see note p.14), the following metallic colours are available for the shaft, the shaft panels, and the landing doors (both sliding and swing doors).

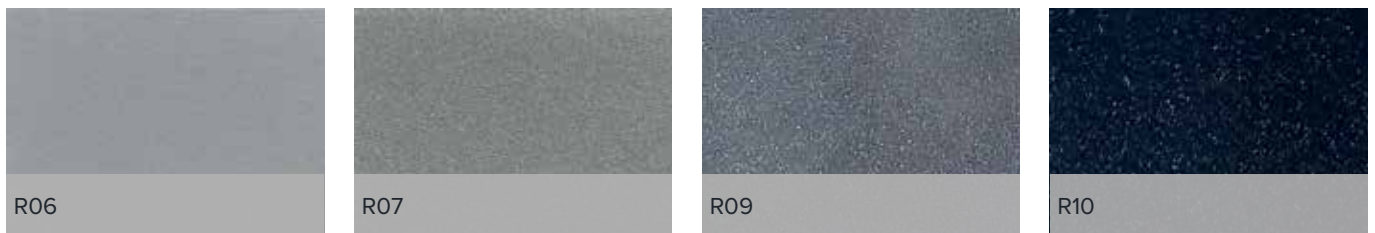

Glass Panels

The following options are offered when glass panels are used in the shaft and doors.

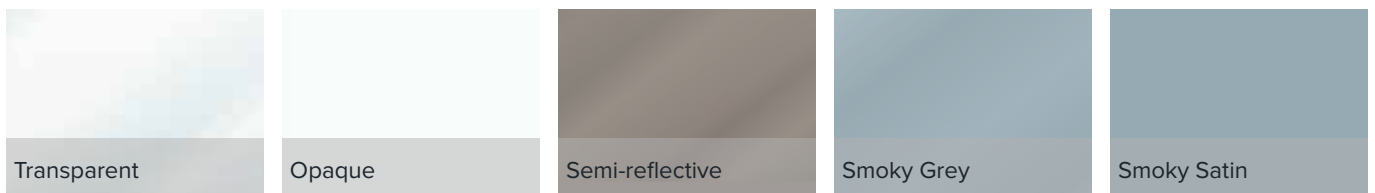

Easy-Snap System

A patented snap-lock fastening system provides quick and easy installation of the horizontal and vertical shaft frames without any additional fastening element.

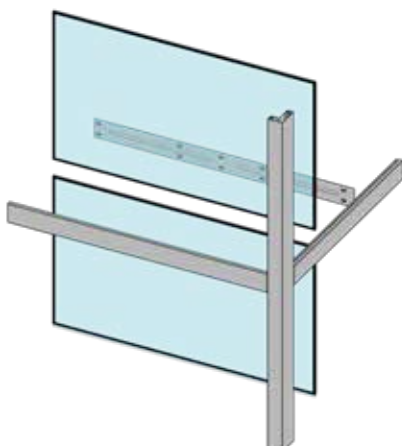

Shaft

ADDITIONAL INFORMATION

Optimised packaging

The lift is delivered with the main parts already assembled to reduce the installation time.

Electrical cables are pre-wired and prepared with connectors. Small parts are packaged into separate and clearly identified boxes.

T-guides are cut to measure to save time at the installation site, and are supplied in parts with a maximum length of 3000 mm. Shaft sections are supplied with a maximum length of 2500 mm.

The lift packaging is optimised to reduce logistics costs and to minimise the risk of breakages during transportation

Electrical cabinet

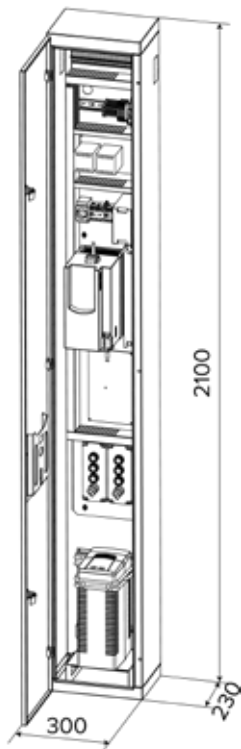

The standard position of the electrical cabinet is in the shaft or integrated in the existing building structure, on the upper floor next to the landing door.

Optionally it can be positioned at the bottom floor next to the landing door or moved to a maximum distance of 5 meters from the guide side of the lift (at bottom or top landing). Please specify your preference when ordering.

Finishes:

- Standard: metal-like skinplate, for indoor application
- Options: Stainless Steel 304 Satin for indoor or RAL paint of choice for indoor and outdoor use.

Dimensions: 300 x 230 x 2100 mm

Pit Requirements

The standard required pit depth is 140 mm. Where the cabin is prepared for the customer's own flooring, an additional 20 mm is required.

In cases with a concrete shaft where the access at the lowest landing is the only one on that side of the shaft, a 250 mm pit is required so that the door mechanism can be accessed during installation and maintenance. This situation is shown on the diagram below.

The Altura Diamond home lift must not be installed where accessible spaces exist below the shaft.

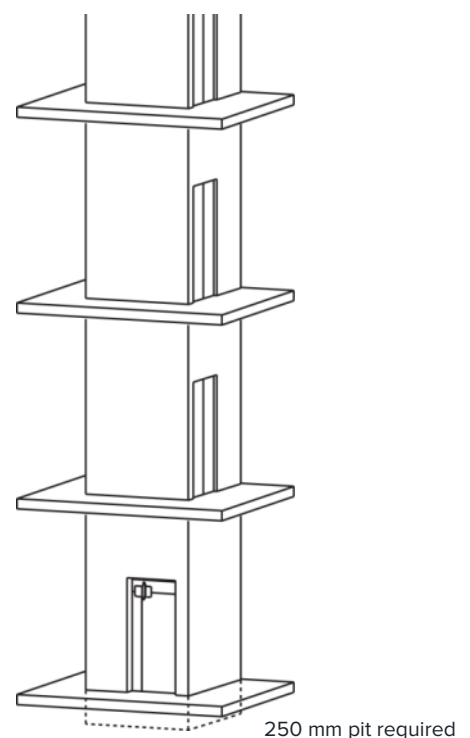

250 mm pit required

Drive

STANDARD FEATURES

The Altura Diamond runs on a gearless cogbelt drive system, offering near-silent travel, with superior comfort and performance.

The cogbelt has an offset double-helix design which smooths the passage of the belt over the pulley, reducing noise and vibrations.



For the safety and comfort of users, the following features are provided as standard on all Altura Diamond Lifts

Battery operated emergency lowering

If the power fails while the lift is between floors, the battery UPS (uninterruptible power supply) back-up system allows the user to move the lift downwards, open the doors and leave the lift by simply pressing any destination button on the control panel. The emergency lowering can also be activated externally from the landing control panel or from the service panel.

Battery protection

The UPS system continuously monitors the back-up batteries to ensure that they are not damaged and that they always hold enough power to run the lift in an emergency. If the back-up battery power level falls below a pre-defined level, the lift cannot be used and will switch itself off until the back-up power level is restored.

Soft start and stop.

A soft start and soft stop device ensures a smooth and comfortable ride. The soft start and stop settings are pre-programmed at the factory, but can be adjusted on-site if required.

Safety first

The Altura Diamond is fully certified to European safety standards. The electronic systems are SIL3 certified by a third party, exceeding standard regulatory requirements for the home lift market. For the greatest possible security, the over-speed governor and the brake are run on separate systems from the main drive.

An overload device prevents the lift from running if the maximum load is exceeded.

Technical Data

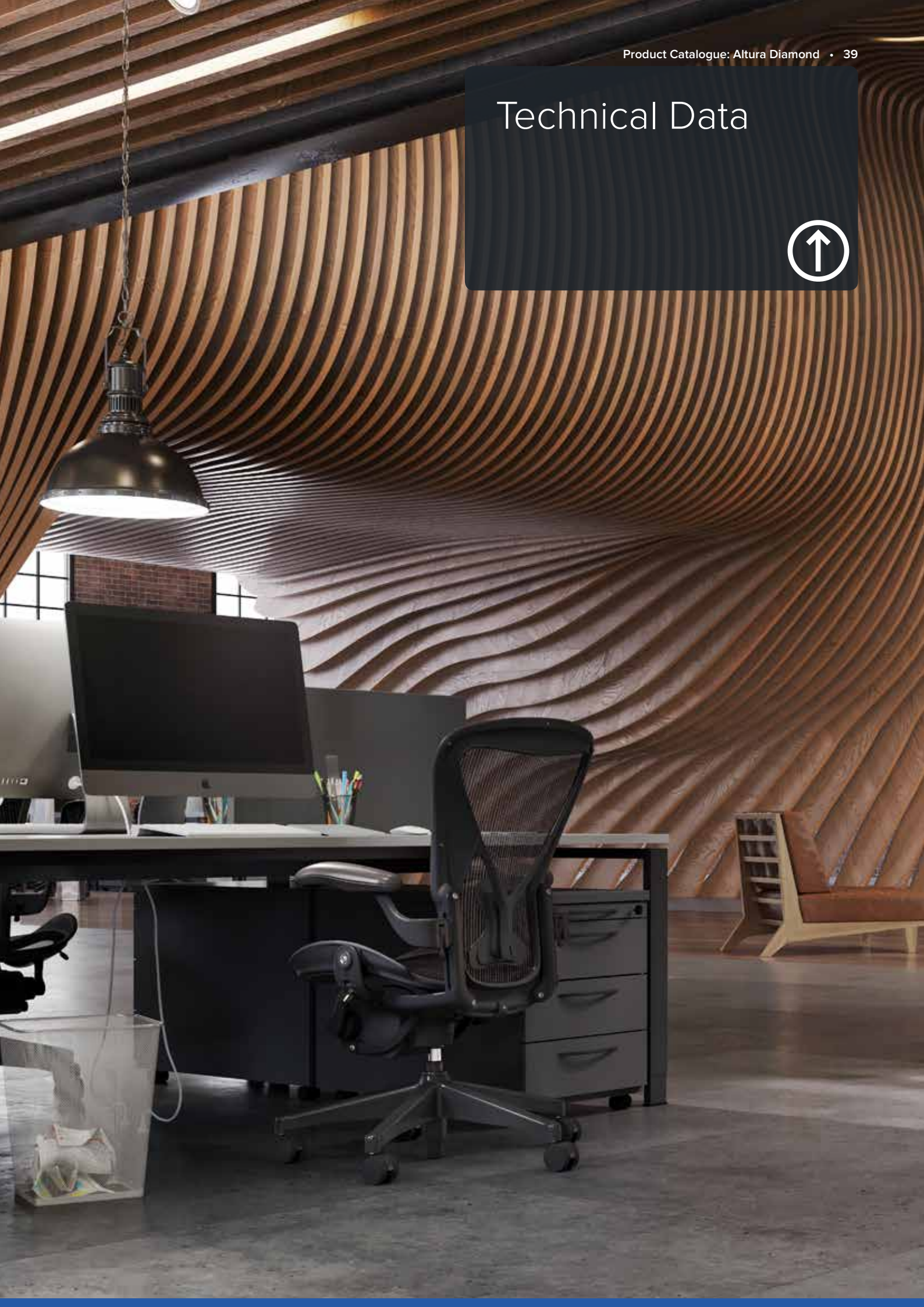

Reaction Forces

Specific details regarding the forces are provided in the technical dossier for each lift order. The information given here indicates loads under typical climate conditions (wind, snow, temperature) and typical fixings of the lift to the building.

Reaction forces from the lift to the building floor:

- The force from the lift is uniformly distributed to the base plate in pit area P, and depends on the travel height and the model version.
- The force from the shaft is distributed to the four corner plates of the shaft structure area S and depends on the travel height.
- The maximum total force depends on the travel height.

Load from the lift to area "P"

Travel (m)	BL41 Load (kN)	BL48 Load (kN)
2	19.5	36.5
4	20	37
6	20.5	37.5
8	21	38
10	21.5	38.5
12	22	39
14	22.5	39.5
16	23	40
18	23.5	40.5

Load from the lift to area "S"

Travel (m)	Total (kN)	kN / corner	N/mm ² / corner
2	12	3	0.16
4	16	4	0.21
6	20	5	0.26
8	24	6	0.32
10	28	7	0.37
12	32	8	0.42
14	36	9	0.47
16	40	10	0.53
18	44	11	0.58

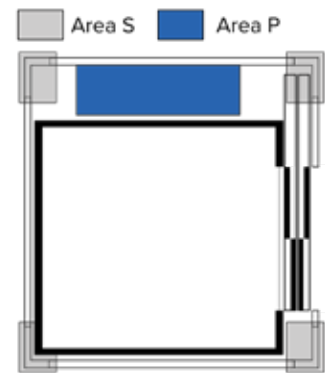

Reaction forces on the wall (rail side)

Concrete shaft

- The force is distributed to the wall through each crossbeam.
- The average vertical distance between each crossbeam is 1.1 - 1.5 m
- The maximum force applied to each fixing point depends on the lift speed.

Speed (m/s)	Fx guide side [kN]	Fy guide side [kN]
≤ 0.15	2.6	0.9
> 0.15	4.7	1.6

Metal shaft

- Typically, the metal structure is fixed to the building every 2000 mm in height by means of expansion bolts.
- A wide range of fixing solutions is available to cover the most stringent applications.
- Under normal conditions, loads do not exceed 3 kN for each fixing point.

Further information can be found in the Fixings Guide.

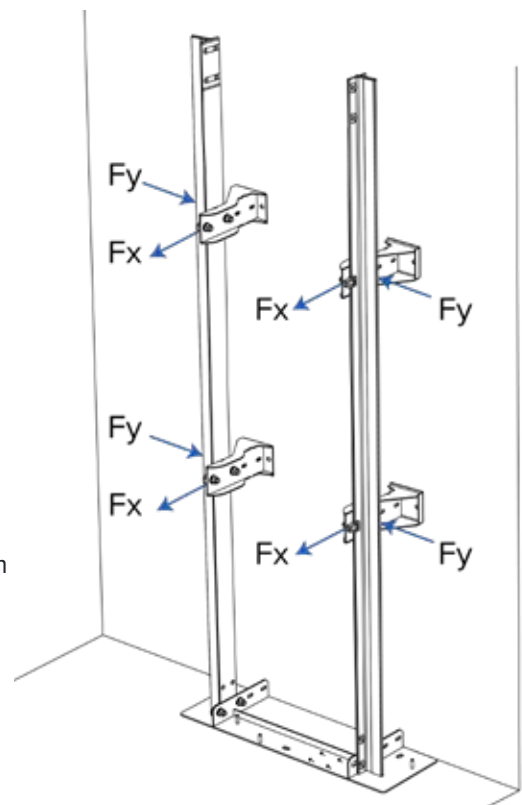

Feasibility Information

PANORAMIC CABIN WALLS & DOORS

For the purposes of load calculations, "panoramic" refers here to any side of the cabin with glass windows, glass door panels or mirrors.

There are no restrictions when combining finishes and optional items for cabins with a floor area smaller than 1,3 m² (nominal load 325 kg). For larger cabins, the weight of the glass means that some limitations exist when combining multiple panoramic sides. A weight check is needed for the configuration of additional options from our catalogue.

The tables below summarise the available combinations based on European regulations. Outside Europe, local regulations may state a different minimum rated load, resulting in differences in the feasibility of panoramic sides.

Simplicity cabin, 1 access

Floor Area	Number of panoramic sides with any option		
	1	2	3
up to 1.3 m ²	full availability	full availability	full availability
1.3 - 1.44 m ²	full availability	full availability	full availability
> 1.44 m ²	full availability	full availability	full availability

Simplicity cabin, 2 accesses

Floor Area	Number of panoramic sides with any option		
	1	2	3
up to 1.3 m ²	full availability	full availability	full availability
1.3 - 1.44 m ²	full availability	full availability	full availability
> 1.44 m ²	full availability	full availability	carpet/PVC floor only

Deluxe cabin, steel walls, 1 access

Floor Area	Number of panoramic sides with any option		
	1	2	3
up to 1.3 m ²	full availability	full availability	full availability
1.3 - 1.44 m ²	full availability	full availability	full availability
> 1.44 m ²	full availability	full availability	carpet/PVC floor only

Deluxe cabin, steel walls, 2 accesses

Floor Area	Number of panoramic sides with any option		
	1	2	3
up to 1.3 m ²	full availability	full availability	full availability
1.3 - 1.44 m ²	full availability	full availability	carpet/PVC floor only
> 1.44 m ²	full availability	carpet/PVC floor only	not available

Deluxe cabin, laminate walls, 1 access

Floor Area	Number of panoramic sides with any option		
	1	2	3
up to 1.3 m ²	full availability	full availability	full availability
1.3 - 1.44 m ²	full availability	full availability	carpet/PVC floor only
> 1.44 m ²	carpet/PVC floor only	carpet/PVC floor only	not available

Deluxe cabin, laminate walls, 2 accesses

Floor Area	Number of panoramic sides with any option		
	1	2	3
up to 1.3 m ²	full availability	full availability	full availability
1.3 - 1.44 m ²	full availability	carpet/PVC floor only	carpet/PVC floor only
> 1.44 m ²	carpet/PVC floor only	not available	not available

Feasibility Information

TYPICAL DIMENSIONS

Narrow and wide layouts

The Altura Diamond is provided with two different layouts according to the cabin dimensions:

Lift Type	Distance between guides	Cabin width min - max
Type I (Narrow)	640 mm	750 - 1120 mm
Type II (Wider)	1000 mm	1121 - 1400 mm

The feasibility diagram below indicates the potential maximum rated load, according to the cabin dimensions and the type of lift.

Each Altura Diamond lift is designed to carry the minimum nominal load of 250 kg/m² in accordance with the EN code. If a higher rated load is required, this should be specified at the order stage so that the correct calculations can be applied.

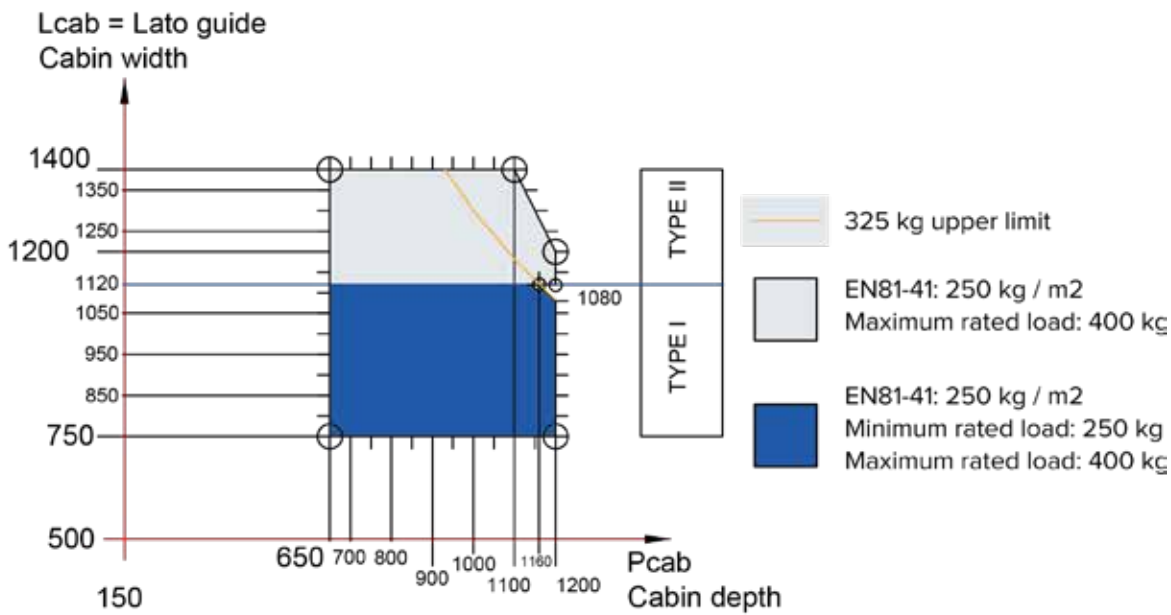

Pre-defined plans

The following pages give a range of predefined plans, based on typical requirements, with pre-selected door layouts and types. These are offered as standard solutions

Other dimensions and door configurations are possible, within the maximum and minimum sizes indicated in the diagram above. We can offer modular plan sizes, using the standard shaft structure elements, or completely customised made-to-measure plans. Please note that customised plan sizes have longer delivery times and additional costs.

Oversized masonry shaft

As a general rule, the Altura Diamond can be installed in a masonry shaft that is larger than the dimensions given in the standard plans, provided that the maximum gap between the cabin and the shaft wall does not exceed 150 mm.

Pre-defined Plans

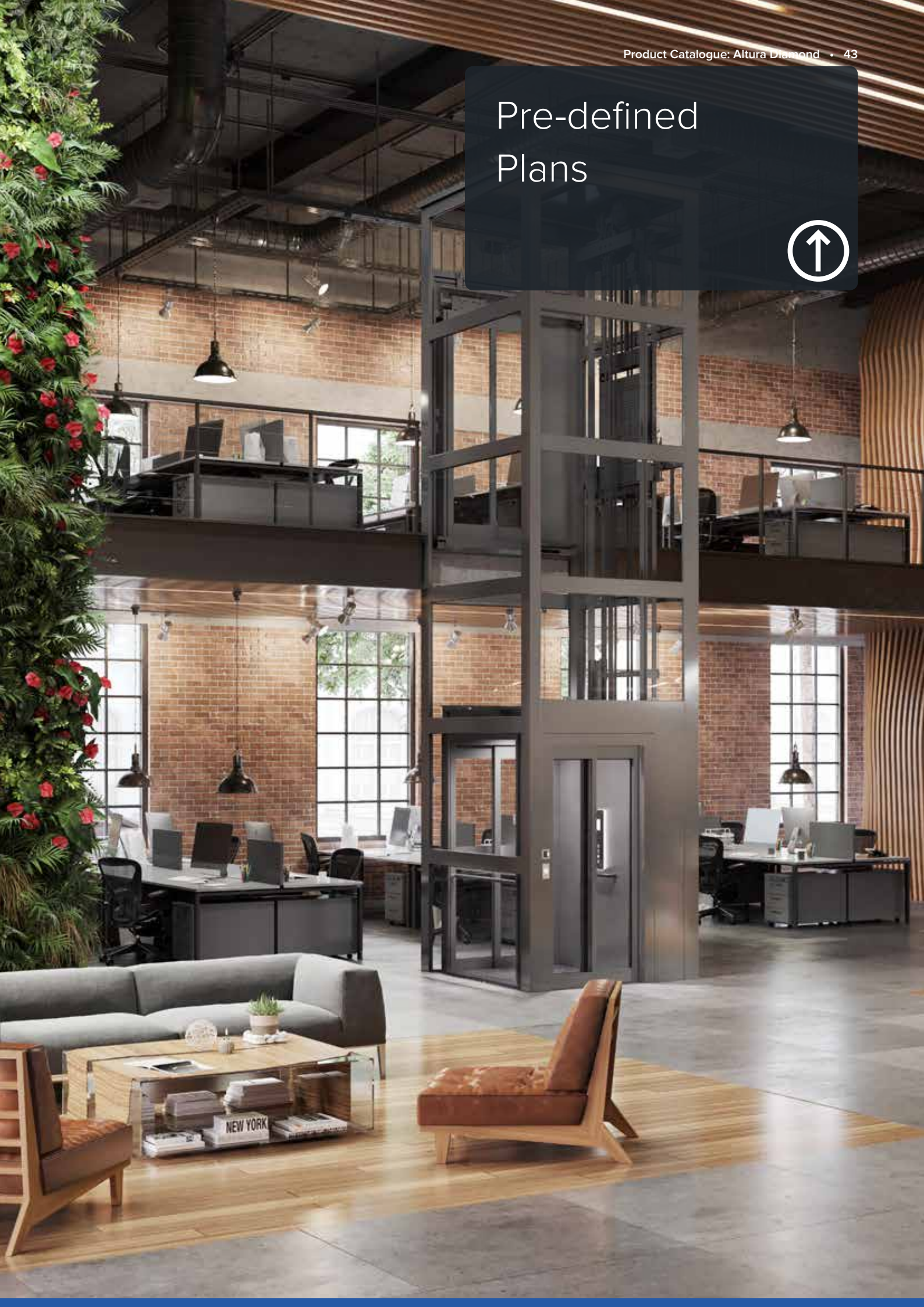

Metallic shaft with sliding doors

Unless otherwise stated, doors are lateral opening two panels (2P). (4P) indicates four panel central opening. EN 81-41 configurations shown in grey.

Frontal Access

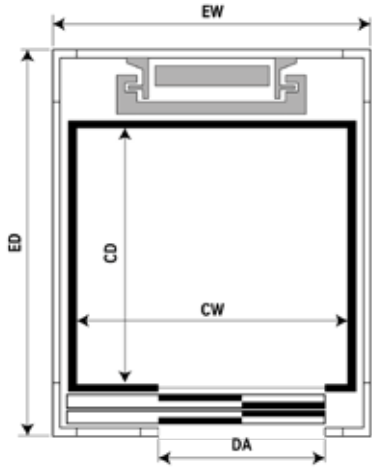

	P1	P2	P3	P4	P5	P6	P7	P8
CW	900	1010	1010	1210	-	1400	1400	1400
CD	1215	815	1015	1015	-	915	1015	1115
EW	1300	1300	1300	1450	-	1600	1600	1600
ED	1900	1500	1700	1700	-	1600	1700	1800
DA	700(4P)	700 (4P) 600 (2P)	700 (4P) 600 (2P)	750	-	850	850	850
Rated Load	270	250	250	300	-	315	350	385

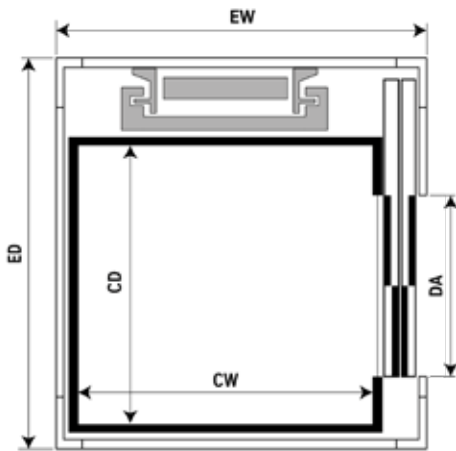

Lateral Access



	P1	P2	P3	P4	P5	P6	P7	P8
CW	900	1010	1010	1210	-	1410	1410	1410
CD	1200	800	1000	1015	-	920	1015	1134
EW	1300	1400	1400	1600	-	1800	1800	1800
ED	1750	1300	1500	1550	-	1450	1550	1650
DA	900	650	800	800	-	750	800	900
Rated Load	270	250	250	300	-	315	350	385

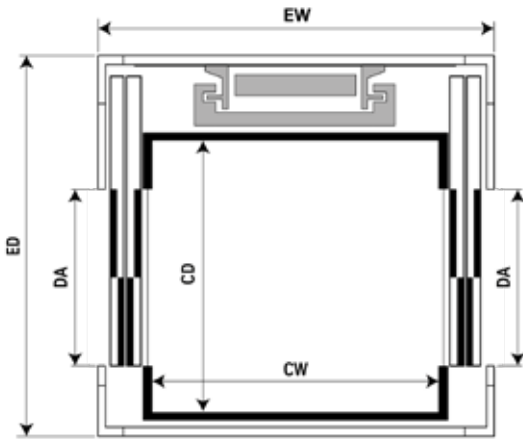

Opposite Accesses



	P1	P2	P3	P4	P5	P6	P7	P8
CW	890	1040	1040	1240	-	1400	1400	1400
CD	1200	795	995	1015	-	920	1034	1134
EW	1450	1600	1600	1800	-	1960	1960	1960
ED	1800	1300	1500	1550	-	1450	1550	1650
DA	900	650	800	800	-	750	800	900
Rated Load	270	250	250	300	-	315	350	385

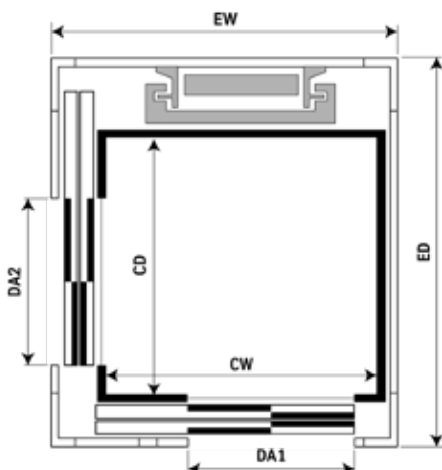

Adjacent Accesses



	P1	P2	P3	P4	P5	P6	P7	P8
CW	900	1010	1010	1210	1210	1400	1400	1400
CD	1215	815	1015	1015	1215	915	1015	1115
EW	1300	1400	1400	1600	1600	1800	1800	1800
ED	1900	1500	1700	1700	1900	1600	1700	1800
DA1	600(4P)	600	700 (4P)	750	850 (2P) 900 (4P)	900	900	900
DA2	900	700	800	800	850	750	800	900
Rated load	270	250	250	300	360	315	350	385

Metallic shaft with folding / swing doors

EN 81-41 configurations shown in grey.

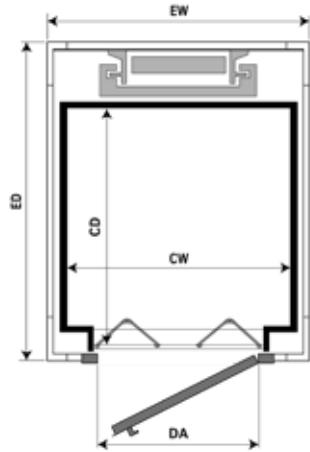

Frontal Access

	P1	P2	P3	P4	P5	P6	P7	P8
CW	930	1000	1000	1200	-	1400	1400	1400
CD	1205	805	1005	1005	-	905	1005	1105
EW	1200	1200	1300	1450	-	1600	1600	1600
ED	1800	1400	1600	1600	-	1500	1600	1700
DA	700	800	800	900	-	900	900	900
Rated Load	270	250	250	300	-	315	350	385

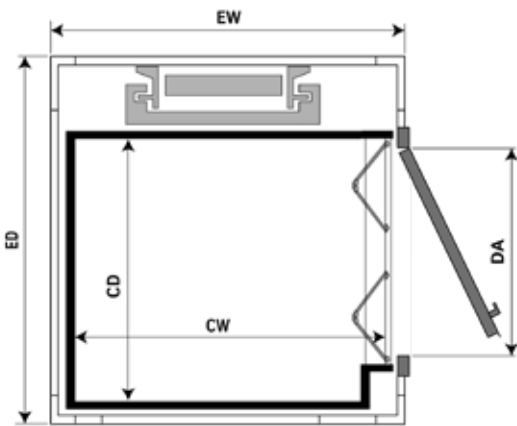

Lateral Access



	P1	P2	P3	P4	P5	P6	P7	P8
CW	900	1000	1000	1200	-	1400	1400	1400
CD	1195	810	1010	1010	-	910	1010	1110
EW	1200	1300	1300	1500	-	1700	1700	1700
ED	1700	1350	1550	1550	-	1450	1550	1650
DA	900	650	850	850	-	750	850	900
Rated Load	270	250	250	300	-	315	350	385

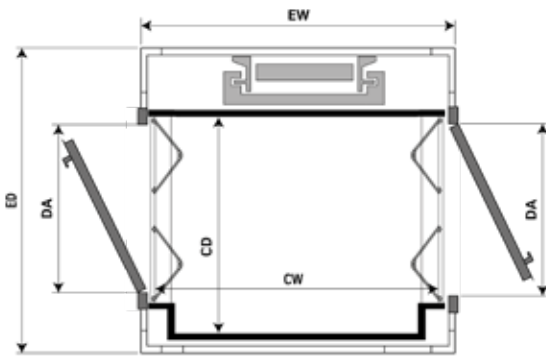

Opposite Accesses



	P1	P2	P3	P4	P5	P6	P7	P8
CW	920	1020	1020	1220	-	1420	1420	1420
CD	1195	795	995	1010	-	920	1035	1135
EW	1300	1400	1400	1600	-	1800	1800	1800
ED	1700	1300	1500	1550	-	1450	1550	1650
DA	900	650	850	850	-	750	850	900
Rated Load	270	250	250	300	-	315	350	385

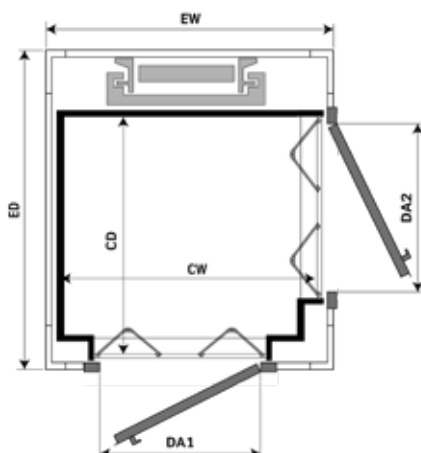

Adjacent Accesses



	P1	P2	P3	P4	P5	P6	P7	P8
CW	900	1000	1000	1200	1200	1400	1400	1400
CD	1205	805	1005	1005	1205	905	1005	1105
EW	1200	1300	1300	1500	1500	1700	1700	1700
ED	1800	1400	1600	1600	1800	1500	1600	1700
DA1	650	750	750	800	900	900	900	900
DA2	900	650	750	800	900	700	800	900
Rated Load	270	250	250	300	360	315	350	385

Concrete shaft with sliding doors

Unless otherwise stated, doors are lateral opening two panels (2P). (4P) indicates four panel central opening. EN 81-41 configurations shown in grey.

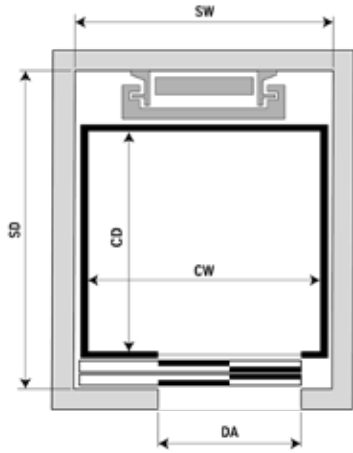

Frontal Access

	P1	P2	P3	P4	P5	P6	P7	P8
CW	900	1010	1010	1210	-	1400	1400	1400
CD	1215	815	1015	1015	-	915	1015	1115
SW	1180	1150 1220	1150 1220	1350	-	1540	1540	1540
SD	1820	1420	1620	1620	-	1520	1650	1720
DA	700(4P)	700 (4P) 600 (2P)	700 (4P) 600 (2P)	750	-	850	850	850
Rated Load	270	250	250	300	-	315	350	385

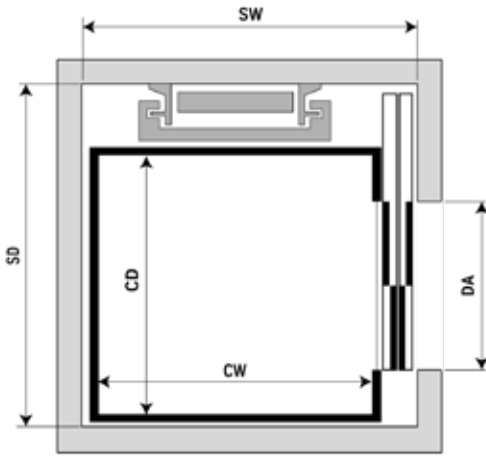

Lateral Access

	P1	P2	P3	P4	P5	P6	P7	P8
CW	900	1010	1010	1210	-	1410	1410	1410
CD	1200	800	1000	1015	-	920	1015	1134
SW	1210	1320	1350	1550	-	1720	1720	1720
SD	1635	1235	1435	1450	-	1335	1450	1570
DA	900	650	800	800	-	750	800	900
Rated Load	270	250	250	300	-	315	350	385

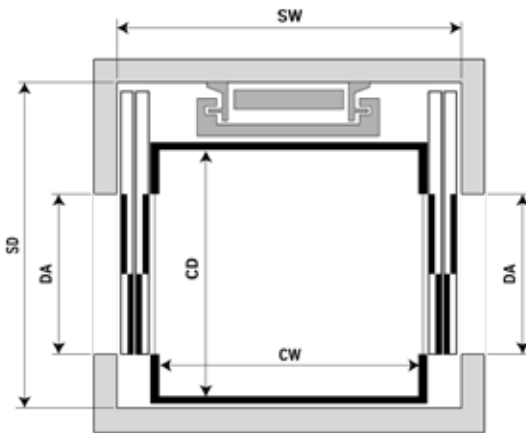

Opposite Accesses

	P1	P2	P3	P4	P5	P6	P7	P8
CW	890	1040	1040	1240	-	1400	1400	1400
CD	1200	795	995	1015	-	920	1034	1134
SW	1370	1520	1520	1720	-	1880	1880	1880
SD	1635	1230	1430	1450	-	1355	1470	1570
DA	900	650	800	800	-	750	800	900
Rated Load	270	250	250	300	-	315	350	385

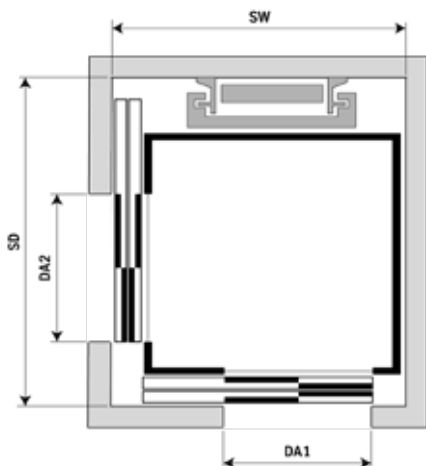

Adjacent Accesses

	P1	P2	P3	P4	P5	P6	P7	P8
CW	900	1010	1010	1210	1210	1400	1400	1400
CD	1210	815	1015	1015	1215	915	1015	1115
SW	1210	1320	1320	1520	1520	1720	1720	1720
SD	1815	1420	1620	1620	1820	1520	1620	1720
DA1	600(4P)	600	700 (4P)	750	850 (2P) 900 (4P)	900	900	900
DA2	900	700	800	800	850 900	750	800	900
Rated load	270	250	250	300	360	315	350	385

Concrete shaft with folding / swing doors

EN 81-41 configurations shown in grey.

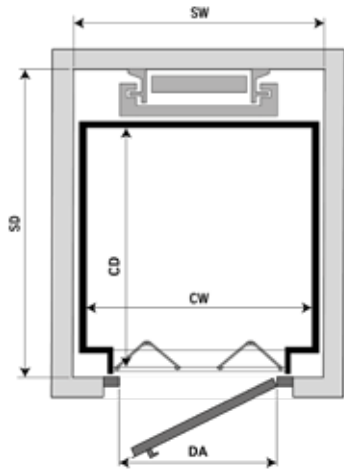

Frontal Access

	P1	P2	P3	P4	P5	P6	P7	P8
CW	930	1000	1000	1200	-	1400	1400	1400
CD	1205	805	1005	1005	-	905	1005	1105
SW	1050	1120	1120	1320	-	1520	1520	1520
SD	1720	1320	1520	1520	-	1420	1520	1620
DA	700	800	800	900	-	900	900	900
Rated Load	270	250	250	300	-	315	350	385

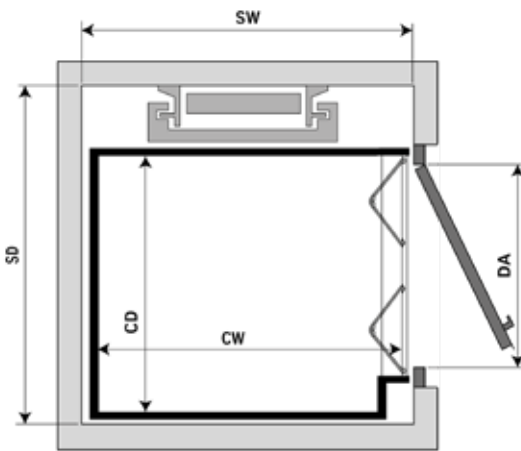

Lateral Access



	P1	P2	P3	P4	P5	P6	P7	P8
CW	900	1000	1000	1200	-	1400	1400	1400
CD	1195	810	1010	1010	-	910	1010	1110
SW	1110	1210	1210	1410	-	1610	1610	1610
SD	1620	1235	1435	1435	-	1335	1435	1535
DA	900	650	850	850	-	750	850	900
Rated Load	270	250	250	300	-	315	350	385

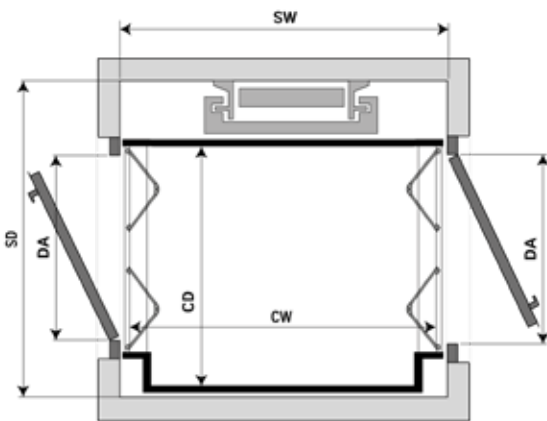

Opposite Accesses



	P1	P2	P3	P4	P5	P6	P7	P8
CW	920	1020	1020	1220	-	1420	1420	1420
CD	1195	795	995	1010	-	920	1035	1135
SW	1220	1320	1320	1460	-	1720	1720	1720
SD	1620	1220	1420	1220	-	1345	1460	1560
DA	900	650	850	850	-	750	850	900
Rated Load	270	250	250	300	-	315	350	385

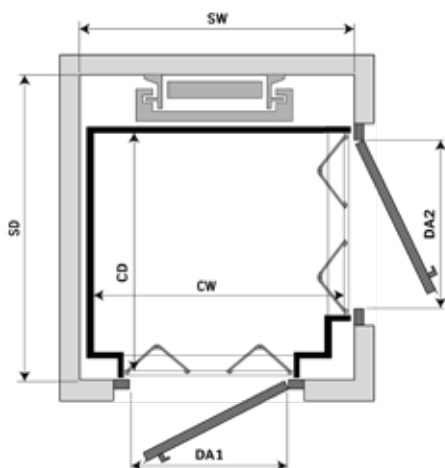

Adjacent Accesses



	P1	P2	P3	P4	P5	P6	P7	P8
CW	900	1000	1000	1200	1200	1400	1400	1400
CD	1205	805	1005	1005	1205	905	1005	1105
EW	1110	1210	1210	1410	1410	1610	1610	1610
ED	1720	1320	1520	1520	1720	1420	1520	1620
DA1	650	750	750	800	900	900	900	900
DA2	900	650	750	800	900	750	800	900
Rated Load	270	250	250	300	360	315	350	385



local Access partner is:



ATECO CORPORATION

اتيكو كورپوريشن

Financial building, Banking Road, From 90th
Road, Redcon Bldg., New Cairo, Cairo

Tel: 26775125- 26774516

Mobile: 01022000282-01000289831

E-mail: info@ateco.co

